

Vita Spa[®] 100 Series Manual





ALERT

Your new spa's GFCI will trip.

A Ground Fault Interrupter (GFCI) Trip Test must occur to allow proper spa function.

Spas that come with MXBP20 and MXBP100 control systems come with special instructions for the installer/electrician. If they have not already advised you on what to do or expect from the GFCI Trip Test, please contact them for instructions.

If the GFCI breaker connected to your spa trips, this is normal behavior. Please reset the breaker and enjoy your spa. The trip test has been completed successfully.

If your spa was not wired to a GFCI breaker or your breaker fails the GFCI Trip Test, the spa will repeatedly attempt (at preset intervals) to trip the breaker in the future until such time that it triggers a GFCI Trip. If a GFCI does not trip properly, your spa's display will show an error message.

GFCI breakers are important safety devices required by code for your hot tub. For more information, refer to the MXBP20 and MXBP100 sections of this manual or your local dealer.



IMPORTANT SAFETY WARNINGS

SAVE THESE INSTRUCTIONS

NOTE: When installing and using this equipment, basic safety precautions should always be taken to reduce the risk of electrical shock, to ensure safe usage, and to safeguard the user's health. Failure to follow instructions and warnings contained in this Owner's Manual, Installation Guide and on the spa/swim spa itself may result in severe personal injury, including death, as well as property damage.

WARNING:

Children should not use spas or hot tubs without adult supervision.

WARNING:

Do not use spas or hot tubs unless all suction guards are installed to prevent body and hair entrapment.

WARNING:

Pregnant, or possibly pregnant, women should consult a physician before using a spa or hot tub.

WARNING:

People with infectious diseases should not use a spa or hot tub.

WARNING:

To avoid injury, exercise care when entering or exiting the spa or hot tub.

WARNING:

Do not use drugs or alcohol before or during the use of a spa or hot tub to avoid unconsciousness and possible drowning.

WARNING:

People using medications and/or having an adverse medical history should consult a physician before using a spa or hot tub.

WARNING:

Water temperature in excess of 100°F (38°C) may be injurious to your health.

WARNING:

Before entering the spa or hot tub, measure the water temperature with an accurate thermometer.

WARNING:

Do not use a spa or hot tub immediately following strenuous exercise.

WARNING:

Prolonged immersion in a spa or hot tub may be injurious to your health.

WARNING:

Maintain water chemistry in accordance with manufacturer's instruction.

WARNING:

Do not permit electric appliances (such as a light, telephone, radio or television) within 5 feet (1.5m) of the spa or hot tub.

WARNING:

The use of alcohol or drugs can greatly increase the risk of fatal hyperthermia in hot tubs and spas.

TABLE OF CONTENTS

IMPORTANT SAFETY WARNINGS	2
TABLE OF CONTENTS	3
IMPORTANT SAFETY INSTRUCTIONS .	4
DOS AND DON'TS OF SPA CARE.....	6
Hyperthermia	6
SPA INSTALLATION	7
European Spas.....	7
SPA Site and Positioning.....	7
Outdoor Installation.....	7
Indoor Installation.....	7
Thermal Creep.....	8
SPA SYSTEM COMPONENTS	9
SPA COMPONENTS	10
JETS AND AIR CONTROLS	11
Jets.....	11
Cleaning or Replacing Jets.....	11
Cleaning Jets.....	11
Air Controls.....	12
ELECTRICAL INFORMATION	13
Important Safety Instructions.....	13
GFCI	13
Residual Current Device.....	13
Installation Options	13
VOLTAGE/AMPERAGE CHART:.....	16
START UP PROCEDURES	18
Priming Your Spa	18
TP500 CONTROL PANEL	19
Main Menus.....	19
Filling Your Spa.....	20
Spa Behavior	20
Temperature & Temp Range.....	21
Mode - Rest and Ready.....	22
Show & Set Time of Day	22
Flip (Invert Display).....	23
Restricting Operation	23
Unlocking.....	23
Adjusting Filtration	23
GFCI Test Feature.....	24
TP600 CONTROL PANEL	25
Button Functions.....	25
Main Menus.....	25
Filling Your Spa.....	26
Spa Behavior	26
Temperature & Temp Range.....	27
Mode - Rest & Ready	28
Show & Set Time-of-Day	28
Flip (invert Display)	29
Restricting Operation	29
Unlocking.....	29
Adjusting Filtration.....	29
GFCI Test Feature	29
WiFi CONNECTIVITY	30
SPA SOAKING & EXERCISE GUIDELINES	31
EQUIPMENT SAFETY FEATURES	34
Automatic Time Outs	34
Common LCD Messages	34
MAINTENANCE	36
Water Chemistry	36
Sanitizing.....	36
pH Level.....	36
Sanitizing with Ozone.....	37
Specialty Chemicals.....	37
Draining your Spa	37
Filter Maintenance	38
Winterizing	38
Spa Cabinet Care	39
Spa Surface Care and Cleaning	39
COMMON WATER PROBLEMS	40
COMMON HARDWARE PROBLEMS	43
SAFETY SIGN	45
LIMITED WARRANTY SUMMARY	45
COPYRIGHTS AND TRADEMARKS	46
NOTES	47

IMPORTANT SAFETY INSTRUCTIONS

READ AND FOLLOW ALL INSTRUCTIONS

- WARNING** - To reduce the risk of injury, do not allow children to use spa unless they are closely supervised at all times.
- A wire connector is provided on this unit to connect a minimum 6 AWG (5.15 mm²) solid copper conductor between this unit and any metal equipment, metal enclosures of electrical equipment, metal water pipe or conduit within 5 feet (1.5m) of the unit.
- (For cord-connected/convertible units) DANGER** - Risk of injury.
 - Replace damaged cord immediately.
 - Do not bury cord.
 - Connect to a grounded, grounding type receptacle only.
- DANGER** - Risk of Accidental Drowning. Extreme caution must be exercised to prevent unauthorized access by children. To avoid accidents, ensure that children cannot use this spa unless they are supervised at all times.
- DANGER** - Risk of injury. The suction fittings in this spa are sized to match the specific water flow created by the pump. If you must replace the suction fittings or the pump, be sure the flow rates are compatible. Never operate spa if the suction fittings are broken or missing. Never replace a suction fitting with one rated less than the flow rate marked on the original suction fitting.
- DANGER** - Risk of Electric Shock. Install at least 5 feet (1.5m) from all metal surfaces. As an alternative, a spa may be installed within 5 feet (1.5m) of metal surfaces if each metal surface is permanently connected by a minimum 6 AWG (5.15 mm²) solid copper conductor to the wire connector on the terminal box that is provided for this purpose.
- DANGER** - Risk of Electric Shock. Do not permit any electric appliance (such as a light, telephone, radio or television) within 5 feet (1.5m) of the spa.
- WARNING** - To reduce the risk of injury:
 - The water in a spa should never exceed 104°F (40°C).. Temperatures between 100°F (38°C) and 104°F (40°C) are considered safe for a healthy adult. Lower temperatures are recommended for young children and when spa use exceeds 10 minutes.
 - Since excessive water temperatures have a high potential for causing fetal damage during the early months of pregnancy, pregnant or possibly pregnant women should limit spa water temperatures to 100°F (38°C).
 - Before entering spa, measure the water temperature as water temperature regulating devices vary.
 - The use of alcohol, drugs, or medication before or during spa use may lead to unconsciousness with the possibility of drowning.
 - Obese persons and persons with a history of heart disease, low or high blood pressure, circulatory system problems, or diabetes should consult a physician before using a spa.

f. Persons using medication should consult a physician before using a spa since some medication may induce drowsiness while other medication may affect heart rate, blood pressure, and circulation.

SAVE ALL INSTRUCTIONS

NOTE: Check with your state/local code enforcement officer to determine electrical code requirements and compliance. Use a qualified licensed electrician to complete all final spa electrical connections.

Caution: Risk of electrical shock. Read and follow all instructions.

TO AVOID RISK OF ELECTRICAL SHOCK:

1. A green colored terminal or a terminal marked G, GR, Ground, Grounding, or the international symbol  is located on the side of the supply terminal box or compartment. This terminal must be connected to the grounding means provided in the electric supply service panel, using a continuous copper wire equivalent in size to the circuit conductors supplying this equipment.
**IEC Publication 60417, Symbol 5019.*
Never use aluminum wire.
2. At least two lugs marked "BONDING LUGS" are provided on the external surface or on the inside of the supply terminal box or compartment. Connect the local common bonding grid (house-hold ground) in the area of the hot tub or spa to these terminals, using an insulated or bare copper conductor not smaller than No. 6 AWG.
3. All field-installed metal components such as rails, ladders, drains or similar hardware located within 5 ft (1.5m) of the spa or hot tub shall be bonded to the equipment grounding bus with copper conductors only, no smaller than No. 6 AWG.
4. **Never** connect unit to a power supply with a load controller.
5. Install spa in position which provides drainage of electrical component compartments.
6. The electrical supply for this product must include a suitably rated switch or circuit breaker to open all ungrounded supply conductors. This disconnecting means must be readily accessible for operation but installed at least 5 feet

(1.5m) from the spa. All electrical connections should comply with local regulations.

DOS AND DON'TS OF SPA CARE

Do:

- **Save these instructions!**
- Replace the cover immediately after use.
- Keep the cover locked when spa is not in use.
- Be aware of the dangers of a wet and slippery surface. Use caution when entering and exiting your spa.
- Have a licensed electrician or certified technician make all final electrical connections.
- Replace worn, frayed or broken electrical cords.
- Keep the water chemistry correctly balanced. Untreated spa water will cause problems with your spa and equipment as well as being a health risk.
- Clean the spa filter weekly or as needed.
- Position the spa so that all sides remain accessible for maintenance.
- Use a bathing cap for long hair.
- Refer to information on hyperthermia.
- Use only authorized spa care products for the best performance and to keep the water properly balanced.

Don't:

- Use the spa at 104°F (40°C) for long periods of time (more than 30 minutes).
See Hyperthermia, next column.
- Use an extension cord to power your spa.
- Allow anyone to stand on the spa cover. It is not designed to support weight.
- Power the spa unless it is filled with water 5-6 inches below top of spa lip.
- Operate the pump on high speed for ex-

tended periods of time with the cover in place. Extended operation can cause heat build-up and interfere with spa operation.

HYPERTHERMIA

The causes, symptoms, and effects of hyperthermia may be described as follows: hyperthermia occurs when the internal temperature of the body reaches a level several degrees above the normal body temperature of 98.6°F (37°C). The symptoms of hyperthermia include an increase in the internal temperature of the body, dizziness, lethargy, drowsiness, and fainting. The effects of hyperthermia include:

- a. Failure to perceive heat
- b. Failure to recognize the need to exit spa or hot tub
- c. Unawareness of impending hazard
- d. Fetal damage in pregnant women
- e. Physical inability to exit the spa or hot tub
- f. Unconsciousness resulting in the danger of drowning

WARNING - The use of alcohol, drugs, or medication can greatly increase the risk of fatal hyperthermia.

SPA INSTALLATION

The electrical supply for this product must include a suitably rated switch or circuit breaker to open all ungrounded supply conductors to comply with Section 422-20 of the National Electrical Code ANSI/NFPA70-1987. The disconnecting means must be accessible but installed at least 5 feet (1.5 m) from the spa water. All electrical connections should comply with article 680-D of the NEC.

EUROPEAN SPAS

The appliance should be supplied through a residual current device (RCD) with a rated tripping current not exceeding 30 mA. Means for disconnection must be incorporated in the fixed wiring in accordance with the wiring rules. Parts containing live parts, except parts supplied with safety extra-low voltage not exceeding 12 V, must be inaccessible to a person in the bath. Earthed appliances must be permanently connected to fixed wiring.

SPA SITE AND POSITIONING

Locate the spa on solid, level foundation or flooring, keeping in mind the weight of the filled spa in excess of 3,968lbs (1.800 kg) on some models. If you have any doubts about the load bearing ability of your chosen site, contact an architect/building contractor. The entire perimeter of the spa cabinet and spa bottom must be evenly supported. If your spa is installed outdoors, we recommend you provide a concrete pad for the spa to rest on 8ft x 8ft x 4in (2.5m x 2.5m x 10cm).

Failure to provide a level surface could structurally damage your spa and void the warranty. The spa must be installed to allow access for service and maintenance on all four sides; therefore, below grade level or below deck installation is not

recommended.

OUTDOOR INSTALLATION, Consider the following:

1. Local codes pertaining to fencing.
2. Local electrical and plumbing codes.
3. View from your house.
4. Wind direction.
5. Exposure to sunlight.
6. Distance to trees (twigs, leaves and shade).
7. Dressing and bathroom location.
8. Storage area for equipment and chemicals.
9. Location to facilitate adult supervision.
10. Landscaping and nighttime lighting.
11. Accessibility to equipment.
12. Power supply location and foot traffic.

INDOOR INSTALLATION, Consider the following:

1. Indoor spas promote high humidity. Using ventilation fans or commercial grade dehumidifiers will help to reduce humidity.
2. **Floor drains must be provided near the spa to drain off water that may cause falls and/or water damage.**
3. Floor area should be flat with a non-skid finish. Carpeting is not recommended.
4. Walls/ceilings should be made of materials able to withstand high humidity.
5. Floor load bearing capacities must be able to support the concentrated spa weight.
6. Spas should be double checked for leaks before installing to avoid possible water damage. Dealer installation may include this service.
7. Indoor sun rooms can maintain high ambient temperatures which may effect the spa water temperature. It is NOT recommended that you operate your filter cycles for longer than 4 hours per day under these conditions.

8. For units for use in other than single-family dwellings, a clearly labeled emergency switch shall be provided as part of the installation. The switch shall be readily accessible to the occupants and shall be installed at least 5 feet (1.52 m) away, adjacent to, and within sight of the unit.

IMPORTANT: Proper drainage must be provided to keep base dry, especially if installed below ground/in a pit.

THERMAL CREEP

Your spa is manufactured with energy-efficient components and systems that capture heat generated by the equipment, then transfer that heat back to the spa water. In warmer weather or in situations with extended run times, "Thermal Creep" may occur. Thermal Creep is a condition whereby the actual water temperature is higher than the set temperature. To manage "Thermal Creep" you may:

- Vent your cover. Newer covers have removable center seal padding. To remove this padding, open the Velcro on one side of the vinyl pouch and slide the white padding out. If your spa does not have removable center seal padding, you may instead place a folded cloth about ¾" (2cm) thick under all four corners of the cover before you lock it down. Opening the cover at night will also quickly cool the water down if desired.
 - Open all air controls
 - Set your filtration cycles to run during the cooler times of the day or at night
 - Reduce the length of your filter cycles
 - Visit your local dealer for additional guidance
- Thermal Creep only occurs in well-insulated hot tubs. It is not an indication that something is wrong with your spa or its equipment.

Danger: Electrical shock risk. Install at least 5 feet (1.5m) from all metal surfaces

SPA SYSTEM COMPONENTS

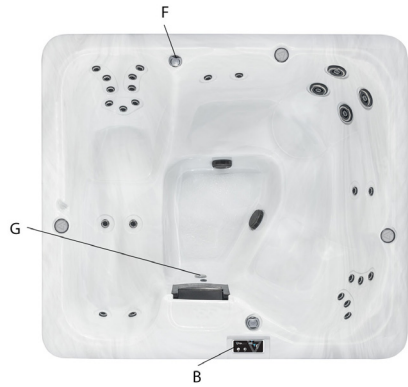

- A. Filter Skimmer/Weir:** Removes floating debris from the water surface, provides a water return path to equipment, and houses water filter element.
- B. Topside Control Panel:** Used to control temperature setting, pump for jets, and light.
- D. Manufacturer's Identification Label:** Contains identification information for warranty service (serial number, model number, etc.) and electrical information (amperage rating and amperage requirements).
- E. Equipment Pack Service Panel (no user serviceable parts):** Spa support system consisting of 2-speed pumps, heater, and associated electrical controls are inside this front panel (not shown).
- F. Air Controls:** Increases or decreases air entering the jets. Close during heating for maximum efficiency.
- G. Digital/Fiber Optic Lighting:** Lighting system that displays multiple colored lights in pre-programmed random, solid or alternating colors (not shown).
- J. Drain Access:** (Adjacent to the equipment service panel) Spa drain faucets.

SPA COMPONENTS

Reference only. Equipment is not always as shown.

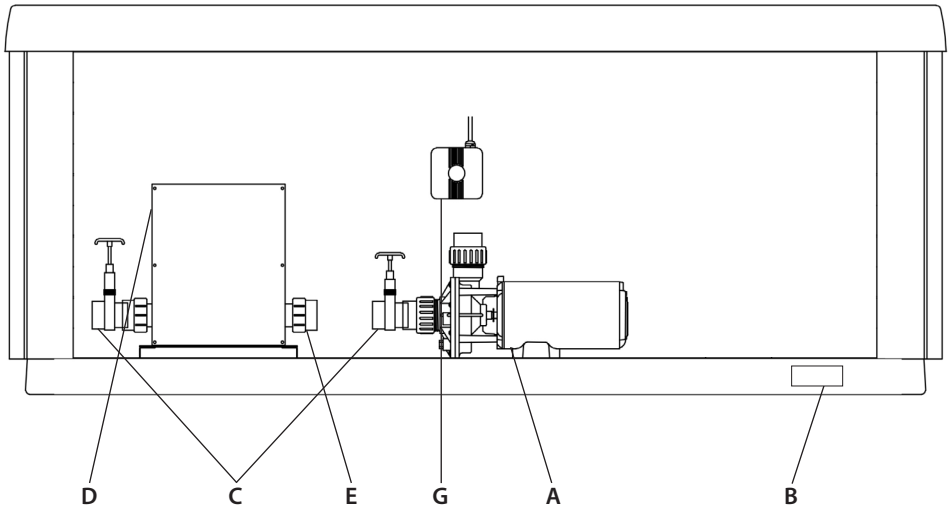

A. Pumps (one pump or more, depending on model): Low speed for efficient water circulation during filtration and heating; high speed for maximum action of the jets. The pump functions are activated by topside controls.

B. Manufacturer's Identification Label: Contains identification information for warranty service (serial number, model number, etc.) and electrical information (ampere rating and ampere requirements).

C. Slice Valve: Used to shut off water flow from the spa to the equipment while servicing. Quantity will vary depending on model. All should be open during normal operations.

D. Electrical Connections: Electrical inputs/wires for the unit connect here.

E. Heater Assembly: Thermostatically controlled and equipped with an overheat safety shut-off.

G. Ozone Generator (Optional)

Note: No consumer serviceable parts. Do NOT attempt to service any of these components yourself. Contact your dealer for assistance.

JETS AND AIR CONTROLS

JETS

All spa jets are individually engineered to provide a unique hydro-massage. Depending on the model, your spa will have a combination of the following jets.

Swim Spa Jets

Swim spa jets are designed to produce a smooth flow of water with high output to create a consistent swim stream. Whether you want to swim or walk/jog against the force of the jets, you will find the flow of water deep enough and swift enough to meet your individual needs.

Hydrotherapy Area Jets

All spa jets are individually engineered to provide a unique hydro-massage. Depending on the model, your spa will have a combination of the following jets.

Directional Jets

Positioned to focus on large muscle groups, these jets deliver a concentrated, high volume stream of water for a deep massage. Each jet is fully adjustable, allowing users to set the water flow to the most comfortable setting. Nozzle can be rotated to target sore muscles.

Rotating Jets

Positioned to focus on muscle tension zones, these jets deliver a spinning V-shaped water stream for a gentle, pulsating massage. Each jet is fully adjustable, allowing for comfortable water flow settings for everyone to enjoy.

Euro Jets

Positioned in the foot well or shoulder areas, these jets deliver a penetrating massage to

dissolve tension. This jet may be the entry point for ozone produced during automatic filtration and therefore it is not adjustable.

Note: Ozone production is stopped when functions are activated on control panel.

CLEANING OR REPLACING JETS

Hard water can cause calcium/mineral buildup that can restrict or bind the jets. A jet consists of a face plate and a nozzle. Rotate these parts weekly and remove/clean to ensure free movement, including the aurora cascades jets.

NOTE: It is not necessary to drain the spa to clean or remove the jets.

Rotating Jets

- Rotate the jet face left and right
- Return face plate to full open position
- Turn the jets on high speed
- Twist the nozzle left and right
- Rotate the nozzle in the socket

NOTE: If the jet insert disengages from the spa housing, see steps to reinstall below.

CLEANING JETS

- To **REMOVE** the jet insert, use the palm of your hand to exert pressure on the face of the jet. Turn counterclockwise until the jet 'clicks'. Gently pull the jet assembly from the housing.
- To **REMOVE** the smaller adjustable jet insert, wear latex or rubber gloves. Turn counterclockwise until you reach the stopping point. Exert more pressure to turn past the stopping point and as the jet 'clicks' pull the insert toward the center of the spa. Gently pull the jet insert from the housing.
- To **CLEAN** the jet insert and housing, use a pressurized hose and spray the inside of the

jet. Soak the jet in a diluted spa cleaning solution, rinse. Wipe the inside of the housing to remove any debris.

- To **REINSTALL** the jet, line up the tab on the backside of the barrel with the groove in the body. Use the palm of your hand to gently tap the jet until it snaps into position.

**NEVER SHUT ALL FULL SIZED
JETS OFF AT ONE TIME!**

AIR CONTROLS

The intensity of the jet action can be controlled by altering the amount of air injected with water through the jets. Your spa has one or more air controls located on the lip of the spa. Each control activates air to specific jets in the spa allowing you to create various combinations and levels of jet action to suit individual preferences. Turn the control counter-clockwise to turn the air off and clockwise to turn air on.

NOTE: Air controls should be closed during heating cycles for maximum energy efficiency.

NOTE: At the start of a filtration cycle, the Optional Air System is activated to purge the lines and ensure complete filtration. Ensure that at least one air control is always fully open.

ELECTRICAL INFORMATION

**Caution: Risk of electrical shock.
Read and follow all instructions.**

IMPORTANT SAFETY INSTRUCTIONS

All electrical connections to this spa package **MUST** be done by a qualified licensed electrician or certified technician in accordance with National Electrical Code (NEC) and with state/local electrical codes in effect at the time of installation.

NOTE: Prior to performing any service to the spa equipment, turn OFF all primary electrical power at the main circuit breaker or disconnect panel.

To make spa electrical connections, remove the exterior equipment access panel, locate the electrical control box, remove the control box cover and follow the wiring diagram on the inside of the control box cover.

Connections should be made using copper conductors only; DO NOT use aluminum.

Connecting wires, circuit breakers or fuses must all be sized to accommodate the Total Ampere load as specified on the equipment label.

This equipment is designed to operate on 50Hz or 60Hz alternating current only, at 240 volts or 120 volts, as required.

NOTE: All unions must be hand-tight and all slice valves must be locked in the OPEN position before filling or refilling spa!

A clip is provided to help keep the slice valve open. Run spa and check for union water leaks before reinstalling front panel.

FOR EUROPE ONLY

The spa is intended for use only in premises having a service current capacity ≥ 100 A per phase, supplied from a distribution network

having a nominal voltage of 230 V. The user shall determine in consultation with the supply authority, if necessary, that the service current capacity at the interface point is sufficient for the spa.

Equipment complying with IEC 61000-3-11.

GFCI

(Ground-Fault Circuit Interrupter)

A qualified licensed electrician must connect the spa to a circuit protected by a GFCI. This is a requirement by the National Electric Code, article 680.44, and is also in compliance with Underwriter's Laboratories, Inc.

RESIDUAL CURRENT DEVICE

The appliance should be supplied through a residual current device (RCD) or Ground Fault Interrupter (GFCI) with a rated tripping current not exceeding 30mA. Means for disconnection must be incorporated in the fixed wiring in accordance with the wiring rules. Parts containing live voltage, except parts supplied with safety extra-low voltage not exceeding 12V, must be inaccessible to a person in the bath. Earthed appliances must be permanently connected to fixed wiring.

INSTALLATION OPTIONS

Refer to the manufacturer's nameplate located on the kick plate to determine your spa's amperage requirements.

Note: Copper wire is strongly recommended for all electrical connections.

Spas installed for 120 volt operation require a 3-wire, 40, 30, 20 or 15 amp., 120 volt sub-feed in non-metallic pipe to the spa

equipment compartment (line 1, neutral and ground). A green colored terminal (or wire connector marked "G", or "GR", or "Grounding") is provided in the control box. To reduce the risk of electrical shock, connect this terminal or connector to the grounding terminal of your electrical service or supply panel with a continuous green insulated copper wire equivalent to the circuit conductor supplying this equipment, but no smaller than No. 12 AWG. A second pressure wire connector is provided on the surface of the control box for bonding to local ground points. To reduce the risk of electrical shock, this connector should be bonded with a No. 6 AWG copper wire to any metal ladders, water pipes, or any metal within 5 ft. of the spa.

Spas installed for 240 volt, 60 Hz, single phase operation require a 4-wire, 60, 50, 40 or 30 amp., 240 volt sub-feed in non-metallic pipe to the spa equipment compartment (line 1, line 2, neutral and ground). A green colored terminal (or wire connector marked "G", or "GR", or "Grounding") is provided in the control box. To reduce the risk of electrical shock, connect this terminal or connector to the grounding terminal of your electrical service or supply panel with a continuous green insulated copper wire equivalent to the circuit conductor supplying this equipment, but no smaller than No. 12 AWG. A second pressure wire connector is provided on the surface of the control box for bonding to local ground points. To reduce the risk of electrical shock, this connector should be bonded with a No. 6 AWG copper wire to any metal ladders, water pipes, or any metal within 5 feet (1.5m) of the spa.

CORD CONNECT

Certain models may be connected with a power cord which contains the GFCI or RCD

breaker. All electrical connections from the control pack to the outlet should be done by a qualified electrician. For your safety, when the electrician is installing the single electrical outlet and waterproof cover, the outlet should be no further than 10 feet (3m) from the spa [N.E.C. Article 680 and all local codes].

The Ground Fault Circuit Interrupter (GFCI) or Residual Current Device (RCD) is located on the power cord. This device is for your protection. It is very important to protect it along with the moisture resistant cover from damage. Test once a month, with the plug connected to the power supply.

NEVER CONNECT SPA TO EXTENSION CORD!

A pressure wire connector is provided on the exterior surface of the control box inside the spa. This is to permit the connection of a ground bonding wire between this point and any metal equipment, enclosures, reinforced concrete pad, pipe, or conduit within 5 feet (1.5m) of the spa (if needed to comply with local building code requirements). The bonding wire must be at least a #10 AWG solid copper wire.

Bond the spa to all exposed metal equipment or fixtures, handrails, and concrete pad per N.E.C. Article 680 and all local codes.

1. Push the "TEST" button on the GFCI/RCD breaker. The spa should stop operating and the GFCI power indicator will go out.
2. Wait 30 seconds, then push the "RESET" button. Power will be restored to the spa and the GFCI/RCD power indicator will turn on. If the GFCI/RCD fails to operate in this manner, your spa may have an electrical malfunction, and you may be risking electrical shock. Turn off all circuits and do not use the spa until the problem has been corrected by an authorized service agent.

WARNING: Removal of the GFCI/RCD from the

spa's power cord will result in an unprotected spa and will void the spa's warranty.

IMPORTANT: Should you ever find the need to move or relocate your spa, it is essential that you understand and apply these installation requirements. Your spa has been carefully engineered to provide maximum safety against electrical shock.

VOLTAGE/AMPERAGE CHART:

240 Volt Installation Units

Electrical Requirements

Requirement

- 240 volt/60 amp, 50 amp, 40 amp, or 30 amp.
- 60 Hz
- Single phase
- 4-wire service (line 1, line 2 neutral and ground)

NOT NORTH AMERICAN

- 240 volt
- 50 Hz
- Single-, two-, or three- phase service
- Refer to wiring diagram or pouch on control system inside cabinet for specific wiring and phase information.

120 Volt Installation Units

Electrical Requirements

Requirement

- 120 volt/30 amp or 15 amp.
- 60 Hz
- Single phase
- 3-wire service (line 1, neutral and ground)

**THIS SECTION
APPLIES TO SPAS
INSTALLED OUTSIDE OF
NORTH AMERICA**

Number	Meaning
1	The heater will only remain running with no more than two pumps on high speed. All pumps will run on high speed when heater is off.
2	The heater will only remain running with Pump 1 on low speed. Only the spa light can operate at the same time without disabling the heater. All pumps will run on high speed when heater is off.

NOTE: ALL SPAS IN THIS TABLE LEAVE THE FACTORY AS 240V AND CAN BE CONVERTED DOWN TO 120V

SPAS THAT ARE CONVERTIBLE (240V TO 120V) North America				
Model	120V/30A	120V/15A	240V/40A	240V/30A
Lune	1	2	1	2
Duet	1	2	1	2
Voeux	1	2	1	2
Image	1	2	1	2

NOTE: Electrical service requirements will change after conversion.

See previous page for explanation of corresponding letters and numbers.

START UP PROCEDURES

Follow recommendations for site location and electrical connection. 6" (15.5cm) below the top lip of the spa is the level at which the water should be maintained.

1. Fill the spa through the filter hole to 6" (15.5cm) below the top of the spa with tap water. **Never use 'softened' water in your spa.** Softened water can impact the chemical balance of the water and lead to degradation of metal plumbing fittings and possible jet plastic damage.
2. After you have assured that the spa/swim spa is full of water and that all plumbing valves are open, turn power on to unit at circuit breaker or disconnect panel.
3. Open the air controls, located on the top lip, and cycle the jets from high to low. Water should come from the therapy jets. If water flow is not established, turn off jets and see Priming Your Spa (next column).

Important: Do not operate the spa without full water flow.

4. Add chemicals. See Chemical Treatment and Water Maintenance section. Follow Operating Insutructions for your particular model to set heat to the desired temperature. Initially, you may find that the spa requires 12 to 14 hours (18 to 24 hours for swim spas) on 230 Volt installations to reach temperature. Keep your thermal cover on the unit and close the air controls to help the heating process.
5. Verify all drain valves are closed, some are under the spa.

PRIMING YOUR SPA

When filling your spa for the first time or after draining and refilling the spa, you may need to bleed air from the system. Should you experience an air-lock on Pump 1, remove the filter cover, insert a garden hose through each center hole that holds the filter as far as possible without using force. Hold the hose in place and turn on the water. Cycle pump 1 from low to high several times, this forces water into the pump and forces the air out. If this does not work or you experience an air-lock on Pump 2, remove the side panel and locate the pump. With the pump on high speed, slowly loosen the discharge (top) pump union until water starts to trickle out. Once water is trickling out, hand tighten the union (do not over tighten as this could cause the union to crack) and replace the side panel.

Pr - Prime/Purge Pumps





This is Not an Error Message.

The Spa has just been powered up and is in Priming Mode for 4 Minutes. Pumps can be turned ON and OFF to remove any air from the plumbing lines and the Heater. Cycle the pumps on and off to verify good water flow and wait 4 minutes or press any temp related button to exit Priming Mode.

TP500 CONTROL PANEL



NOTE: The look of your topside control panel design and buttons will vary according to features available on your spa. See table below for explanations of TP500 Control Panel button functions.

BUTTON	NAME	FUNCTION	MAIN MENUS
	Jets 1	Activates jets on low or high setting	
	Blower	Activates blower	
	Temperature	Changes temperature and allows for navigation through system	<p>If panel has Up & Down temp buttons, pressing either will cause the temperature to flash. Pressing a Temp Button again will adjust the set temp in the direction indicated on the button. When LCD stops flashing, spa will heat to the new set temp when required.</p> <p>If panel has a single Temp Button, pressing the button will cause temp to flash. Pressing the button again will cause the temp to change in one direction (up). After allowing the display to stop flashing, pressing the Temp Button will cause the temp to flash and the next press will change the temp in the opposite direction (down).</p>
	Light	Activates lights and chooses	The LIGHT button is used to activate spa lights
		Menu	Used to access and cycle through menus

FILLING YOUR SPA

PREPARATION AND FILLING

Fill the spa 5-6" (13-15cm) below the lip of the spa. Open all valves and jets in the plumbing system before filling to allow as much air as possible to escape from the plumbing and the control system during the filling process.

PRIMING MODE

This mode will last 4-5 minutes or you can manually exit the priming mode after the pump(s) have primed. Regardless of whether the priming mode ends automatically or you manually exit the priming mode, the system will automatically return to normal heating and filtering at the end of the priming mode. During the priming mode, the heater is disabled to allow the priming process to be completed without the possibility of energizing the heater under low-flow/no-flow conditions. Nothing comes on automatically, but the pump(s) can be energized by pushing the "Jet" buttons. If the spa has a Circ Pump, it can be activated by pressing the "Light" button during Priming Mode.

PRIMING THE PUMPS

After the display has gone through start up screens: "RUN" "PMPS" "PURG" "AIR" "-- -- --", push "Jet" button once to start Pump 1 in low-speed and again to switch to high-speed. Push the Pump 2 button (if you have a 2nd pump) to turn it on. The pumps will not be running in high-speed to facilitate priming. If the pumps have not primed after 2 minutes, and water is not flowing from the jets in the spa, turn off the pumps and repeat.

NOTE: Turning the power off/on again will initiate a new pump priming session. Sometimes turning the pump off/on helps it to prime. If the pumps will not prime after 5 times, turn power off and call for service.

IMPORTANT: A pump should not be allowed to run without priming for more than 2 minutes. Under NO circumstances should a pump be allowed to run without priming beyond the end of the 4-5 minute priming mode. Doing so may cause damage to the pump and cause the system to energize the heater and go into an overheat condition.

EXITING PRIMING MODE

Manually exit Priming Mode by pressing either Temperature button. If you do not manually exit the priming mode, it will be automatically terminated after 4-5 minutes. Be sure that the pump(s) have been primed by this time. Once the system has exited Priming Mode, the top-side panel will momentarily display the set temperature but the display will not show the temperature yet because the system requires approximately 1 minute of water flowing through the heater to determine the water temperature and display it accurately.

SPA BEHAVIOR

Pumps

Press the "Jets 1" button once to turn pump 1 on or off, and to shift between low- and high-speeds if equipped. If left running, the pump will turn off after a time-out period. The pump 1 low-speed will time out after 30 minutes. The high-speed will time out after 30 minutes. On non-circ systems, the low-speed of pump 1 runs when the blower or any other pump is on. If the spa is in Ready Mode, Pump 1 low may also activate for at least 1 minute every 30 minutes to detect the spa temperature and then to heat to the set temperature if needed. When the low-speed turns on automatically, it cannot be deactivated from the panel, however the high speed may be started.

Circulation Pump Modes

The circ pump (if your spa is equipped with one) operates continuously (24 hours) with the exception of turning off for 30 minutes at a time when the water temperature reaches 3°F (1.5°C) above the set temperature (most likely to happen in very hot climates).

Filtration and Ozone

On non-circ systems, Pump 1 low and the ozone generator will run during filtration. On circ systems, the ozone will run with the circ pump.

The system is factory-programmed with one filter cycle that will run in the evening (assuming the time-of-day is properly set) when energy rates are often lower. The filter time and duration are programmable. A second filter cycle can be enabled as needed. At the start of each filter cycle, the blower (if there is one) or Pump 2 (if there is one) will run briefly to purge its plumbing to maintain good water quality.

Freeze Protection

If the temperature sensors within the heater detect a low enough temperature, the pump(s) and the blower automatically activate to provide freeze protection.

The pump(s) and blower will run either continuously or periodically depending on conditions.

In colder climates, an optional additional freeze sensor may be added to protect against freeze conditions that may not be sensed by the standard sensors. Auxiliary freeze sensor protection acts similarly except with the temperature thresholds determined by the switch. See your dealer for details.

Clean-up Cycle (optional)

When a pump or blower is turned off by a button press or after it has timed out for

30 minutes, a clean-up cycle runs for 30 minutes. Pump 1 on Low Speed and the ozone generator will run for the set time. The pump and the ozone generator will run for 30 minutes or more, depending on the system. On some systems, you can change this setting.

TEMPERATURE & TEMP RANGE

Adjusting the Set Temperature

Pressing Up or Down temperature buttons will cause the temperature to flash. Pressing a temperature button again will adjust the set temperature in the direction indicated on the button. When the LCD stops flashing, the spa will heat to the new set temperature.

If the panel has a single temperature button, pressing the button will cause the temperature to flash. Pressing the button again will cause the temperature to change in one direction (e.g. UP). After allowing the display to stop flashing, pressing the Temperature Button will cause the temperature to flash and the next press will change the temperature in the opposite direction (e.g. DOWN).

Press-and-Hold

If a Temperature button is pressed and held when the temperature is flashing, the temperature will continue to change until the button is released. If only one temperature button is available and the limit of the Temperature Range is reached when the button is being held, the progression will reverse direction.

Dual Temperature Ranges

This system incorporates two temperature range settings with independent set temperatures. The High Range designated in the display by an “up” arrow, and the Low

Range designated in the display by a “down” arrow. These ranges can be used for various reasons, with a common use being a “ready to use” setting vs. a “vacation” setting.

The Ranges are chosen using the menu structure below. Each range maintains its own set temperature as programmed by the user. This way, when a range is chosen, the spa will heat to the set temperature associated with that range.

For example:

High Range may be set between 80°F - 104°F (26°-40°C).

Low Range may be set between 50°F - 99°F (10°-26°C).

Freeze Protection is active in either range.

MODE - REST AND READY

In order for the spa to heat, a pump needs to circulate water through the heater. The pump that performs this function is known as the “primary pump.” The primary pump can be either a 2-Speed Pump 1 or a circulation pump.

If the primary pump is a 2-Speed Pump 1, **READY** Mode (indicated by **R**) will circulate water periodically, using Pump 1 Low, in order to maintain a constant water temperature, heat as needed, and refresh the temperature display. This is known as “polling.”

REST Mode (indicated by a sideways **IR**) will only allow heating during programmed filter cycles. Since polling does not occur, the temperature display may not show a current temperature until the primary pump has been running for a minute or two.

Circulation Mode

If the spa is configured for 24HR circulation, the primary pump generally runs continuously. Since the heater pump is always

running, the spa will maintain set temperature and heat as needed in Ready Mode, without polling.

In **Rest Mode**, the spa will only heat to set temperature during programmed filter times, even though the water is being filtered constantly when in Circulation Mode.

Ready-in-Rest Mode

READY/REST (R w/ a sideways IR) appears in the display if the spa is in Rest Mode and “Jets” is pressed. It is assumed the spa is being used and will heat to set temperature. The primary pump will run until set temperature is reached, or 1 hour has passed. After 1 hour, the System will revert to Rest Mode. This mode can also be reset by entering the Mode Menu and changing the Mode.

SHOW & SET TIME OF DAY

Setting the time-of-day can be important for determining filtration times and other background features. When in the TIME menu, SET TIME will flash on the display if no time-of-day is set in the memory. 24-hour time display can be set under the PREF menu.

Note: This note refers to systems that do not keep track of Time-of-Day when powered down. If power is interrupted to such a system, Time-of-Day is not stored. The system will still operate and all other user settings will be stored. If filter cycles are required to run at a particular time of day, resetting the clock will return the filter times to the actual programmed periods. When such a system starts up, it defaults to 12:00 Noon, so another way to get filter times back to normal is to start up the spa at noon on any given day. SET TIME will still flash in the TIME Menu until the time is actually set, but since the spa started at

noon, the filter cycles will run as programmed.

FLIP (INVERT DISPLAY)

From the main screen, press the Menu/Select repeatedly until FLIP appears in the LCD. Press the Temperature button so that FLIP appears inverted on the LCD. Press the menu button to return to the Main Screen and it will appear inverted.

RESTRICTING OPERATION

The control can be restricted to prevent unwanted use or temperature adjustments. Locking the panel prevents the controller from being used, but all automatic functions are still active. Locking the Temperature allows Jets and other features to be used, but the Set Temperature and other programmed settings cannot be adjusted. Temperature Lock allows access to a reduced selection of menu items. These include Set Temperature, FLIP, LOCK, UTIL, INFO, and FALT LOG.

LOCKING TEMPERATURE Press the Menu/Select button repeatedly until LOCK appears in the LCD. Press the Temperature button until TEMP appears in the LCD. Then press the Temp button until ON appears. Press Menu/Select to set.

LOCKING PANEL Press the Menu/Select button repeatedly until LOCK appears in the LCD. Press the Temperature button. Then press the Menu/Select button until PANL appears. Press the Temp button until ON appears. Press Menu/Select to set.

UNLOCKING

This Unlock sequence may be used from any screen that may be displayed on a restricted

panel. While pressing and holding the Temperature button (or UP button if available), slowly press and release the Menu/Select button two times. "UNLK" will display on the screen and after a few seconds, will revert to main screen.

NOTE: If the panel has both an UP and a Down button, the ONLY button that will work in the Unlock Sequence is the UP button.

The temperature will not Unlock if the Unlock sequence is done while the panel is displaying "LOCK".

ADJUSTING FILTRATION

Main Filtration

Filter cycles are set using a start time and a duration. Start time is indicated by an "A" or "P" in the bottom right corner of the display. Duration has no "A" or "P" indication. Each setting can be adjusted in 15-minute increments. The panel calculates the end time and displays it automatically.

To enter filter cycles, press Menu/Select repeatedly until FLTR appears in the LCD (with a 1 on the right hand side). Press the temperature button until BEGN shows, and press the temperature button again until the LCD shows/flashes a start time. Use the temperature button to set the start hour and press the menu/select button. The minutes will show/flash on the LCD. Use the temperature button to set the 15-minute increment, and press the Menu/Select button so set.

RUN will flash on the LCD, then HRS. Use the temperature button to set the Filter 1 length in hours, and press the Menu/Select button until the minutes on the clock are flashing.

Press the temperature button twice to set the 15-minute increment. Then press Menu/Select to set.

F1 will show on the LCD, then ENDS. Use the temperature button to set the end time.

Filter Cycle 2 - Optional Filtration

Filter Cycle 2 is OFF by default. Follow the same procedures under "FLTR" (with a 2 on the right hand side) to set up filter cycle 2.

It is possible to overlap Filter Cycle 1 and Filter Cycle 2, which will shorten overall filtration by the overlap amount.

Purge Cycles

In order to maintain sanitary conditions, secondary Pumps and/or a Blower will purge water from their respective plumbing by running briefly at the beginning of each filter cycle.

If Filter Cycle 1 is set for 24 hours, enabling Filter Cycle 2 will initiate a purge when Filter Cycle 2 is programmed to begin.

GFCI TEST FEATURE

A GFCI is an important safety device and is required equipment on hot tub installations in North America. Your spa may be equipped with a GFCI Protection feature. (UL rated systems only). If your spa has this feature enabled by the manufacturer, the GFCI Trip Test must occur to allow proper spa function.





Within 7 days after startup, the spa will trip the GFCI to test it. The GFCI must be reset once it has tripped. After passing the GFCI Trip Test, any subsequent GFCI trips will indicate a

ground fault or other unsafe condition and the power to the spa must be shut off until a service person can correct the problem.

TP600 CONTROL PANEL



NOTE: The look of your topside control panel design and buttons will vary according to brand and features available on your spa. See table below for pictures and explanation of TP600 Control Panel button functions.

BUTTON	NAME	FUNCTION	MAIN MENUS
	Jets 1	Activates jets on low or high setting	<p>NAVIGATION</p> <p>Navigating the entire menu structure is done with 3 buttons on the control panel: Temperature Up, Temperature Down and Light buttons.</p> <p>Panels have separate WARM (Up) and COOL (down) buttons which are used to increase or decrease the temperature. These buttons are also used to navigate through menus.</p> <p>The LIGHT button is used to activate spa lights and is also used to choose various menus to navigate each section.</p> <p>Typical use of the Temperature buttons allows changing the Set Temperature while the numbers are flashing in the LCD screen. Numbers will begin flashing when either one of the temperature buttons are pressed.</p> <p>Pressing the LIGHT button while the numbers are flashing will take you to the menus.</p> <p>The menus can be exited with certain button presses. Simply waiting for approximately 10 seconds will return the panel operation to normal.</p>
	Blower	Activates blower	
	Temperature Up	Increases temperature and allows for navigation through system	
	Temperature Down	Decreases temperature and allows for navigation through system	
	Light	Activates lights and chooses menus to navigate through system	

FILLING YOUR SPA

PREPARATION AND FILLING

Fill the spa 5-6" (13-15cm) below the lip of the spa. Open all valves and jets in the plumbing system before filling to allow as much air as possible to escape from the plumbing and the control system during the filling process.

PRIMING MODE

This mode will last 4-5 minutes or you can manually exit the priming mode after the pump(s) have primed. Regardless of whether the priming mode ends automatically or you manually exit the priming mode, the system will automatically return to normal heating and filtering at the end of the priming mode. During the priming mode, the heater is disabled to allow the priming process to be completed without the possibility of energizing the heater under low-flow/no-flow conditions. Nothing comes on automatically, but the pump(s) can be energized by pushing the "Jet" buttons. If the spa has a Circ Pump, it can be activated by pressing the "Light" button during Priming Mode.

PRIMING THE PUMPS

After the display has gone through start up screens: "RUN" "PMPS" "PURG" "AIR" "-- -- --", push "Jet" button once to start Pump 1 in low-speed and again to switch to high-speed. Push the Pump 2 button (if you have a 2nd pump) to turn it on. The pumps will not be running in high-speed to facilitate priming. If the pumps have not primed after 2 minutes, and water is not flowing from the jets in the spa, turn off the pumps and repeat.

NOTE: Turning the power off/on again will initiate a new pump priming session. Sometimes turning the pump off/on helps it to prime. If the pumps will not prime after 5 times, turn power off and call for service.

IMPORTANT: A pump should not be allowed to run without priming for more than 2 minutes. Under NO circumstances should a pump be allowed to run without priming beyond the end of the 4-5 minute priming mode. Doing so may cause damage to the pump and cause the system to energize the heater and go into an overheat condition.

EXITING PRIMING MODE

Manually exit Priming Mode by pressing either Temperature button. If you do not manually exit the priming mode, it will be automatically terminated after 4-5 minutes. Be sure that the pump(s) have been primed by this time. Once the system has exited Priming Mode, the top-side panel will momentarily display the set temperature but the display will not show the temperature yet because the system requires approximately 1 minute of water flowing through the heater to determine the water temperature and display it accurately.

SPA BEHAVIOR

Pumps

Press the "Jets 1" button once to turn pump 1 on or off, and to shift between low- and high-speeds if equipped. If left running, the pump will turn off after a time-out period. The pump 1 low-speed will time out after 30 minutes. The high-speed will time out after 30 minutes. On non-circ systems, the low-speed of pump 1 runs when the blower or any other pump is on. If the spa is in Ready Mode, Pump 1 low may also activate for at least 1 minute every 30 minutes to detect the spa temperature and then to heat to the set temperature if needed. When the low-speed turns on automatically, it cannot be deactivated from the panel, however the high speed may be started.

Circulation Pump Modes

The circ pump (if your spa is equipped with one) operates continuously (24 hours) with the exception of turning off for 30 minutes at a time when the water temperature reaches 3°F (1.5°C) above the set temperature (most likely to happen in very hot climates).

Filtration and Ozone

On non-circ systems, Pump 1 low and the ozone generator will run during filtration. On circ systems, the ozone will run with the circ pump.

The system is factory-programmed with one filter cycle that will run in the evening (assuming the time-of-day is properly set) when energy rates are often lower. The filter time and duration are programmable. A second filter cycle can be enabled as needed. At the start of each filter cycle, the blower (if there is one) or Pump 2 (if there is one) will run briefly to purge its plumbing to maintain good water quality.

Freeze Protection

If the temperature sensors within the heater detect a low enough temperature, the pump(s) and the blower automatically activate to provide freeze protection. The pump(s) and blower will run either continuously or periodically depending on conditions.

In colder climates, an optional additional freeze sensor may be added to protect against freeze conditions that may not be sensed by the standard sensors. Auxiliary freeze sensor protection acts similarly except with the temperature thresholds determined by the switch. See your dealer for details.

Clean-up Cycle (optional)

When a pump or blower is turned off by a button press or after it has timed out for

30 minutes, a clean-up cycle runs for 30 minutes. Pump 1 on Low Speed and the ozone generator will run for the set time. The pump and the ozone generator will run for 30 minutes or more, depending on the system. On some systems, you can change this setting.

TEMPERATURE & TEMP RANGE

Adjusting the Set Temperature

Pressing Up or Down temperature buttons will cause the temperature to flash. Pressing a temperature button again will adjust the set temperature in the direction indicated on the button. When the LCD stops flashing, the spa will heat to the new set temperature.

Press-and-Hold

If a Temperature button is pressed and held when the temperature is flashing, the temperature will continue to change until the button is released.

Dual Temperature Ranges

This system incorporates two temperature range settings with independent set temperatures. The High Range designated in the display by an "up" arrow, and the Low Range designated in the display by a "down" arrow. These ranges can be used for various reasons, with a common use being a "ready to use" setting vs. a "vacation" setting.

The Ranges are chosen using the menu structure below. Each range maintains its own set temperature as programmed by the user. This way, when a range is chosen, the spa will heat to the set temperature associated with that range.

For example:

High Range may be set 80°F - 104°F (26°-40°C).

Low Range may be set 50°F - 99°F (10°-26°C).

Freeze Protection is active in either range.

MODE - REST AND READY

In order for the spa to heat, a pump needs to circulate water through the heater. The pump that performs this function is known as the "heater pump." The heater pump can be either a 2-Speed Pump 1 or a circulation pump. If the heater pump is a 2-Speed Pump 1,

READY Mode will circulate water every 1/2 hour, using Pump 1 Low, in order to maintain a constant water temperature, heat as needed, and refresh the temperature display. This is known as "polling."

REST Mode will only allow heating during programmed filter cycles. Since polling does not occur, the temperature display may not show a current temperature until the heater pump has been running for a minute or two.

Circulation Mode

If the spa is configured for 24HR circulation, the heater pump generally runs continuously. Since the heater pump is always running, the spa will maintain set temperature and heat as needed in Ready Mode, without polling. In Rest Mode, the spa will only heat to set temperature during programmed filter times, even though the water is being filtered constantly when in Circulation Mode.

Ready-in-Rest Mode

READY/REST appears in the display if the spa is in Rest Mode and Jet 1 is pressed. It is assumed the spa is being used and will heat to set temperature. While Pump 1 High can be turned on and off, Pump 1 Low will run until set temperature is reached, or 1 hour has passed. After 1 hour, the System will revert to Rest Mode. This mode can also be reset by entering the Mode Menu and changing it.

SWITCHING FROM READY TO REST MODE

From the screen, press a temp. button until temperature flashes. While flashing, press Light repeatedly until MODE appears on screen. Use a temperature button to move to the next mode. Press Light to select.

SHOW & SET TIME OF DAY

Setting the time-of-day can be important for determining filtration times and other background features. From the main menu, activate the temperature flashing. While the temperature is flashing, press "Light" repeatedly until "TIME" is displayed on the screen. Proceed to set current time using the up and down temperature buttons. When in the TIME menu, SET TIME will flash on the display if no time-of-day is set in the memory. 24-hour time display can be set under the PREF menu.

Note: If power is interrupted to the system, Time-of-Day is not stored. The system will still operate and all other user settings will be stored. If filter cycles are required to run at a particular time of day, resetting the clock will return the filter times to the actual programmed periods. When the system starts up, it defaults to 12:00 Noon, so another way to get filter times back to normal is to start up the spa at noon on any given day. SET TIME will still flash in the TIME Menu until the time is actually set, but since the spa started at noon, the filter cycles will run as programmed.

FLIP (INVERT DISPLAY)

From the main screen, activate the temperature flashing. While the temperature is flashing, press “Light” repeatedly until “FLIP” is displayed on the screen. While “FLIP” is displayed, press either the up or down temperature button to invert the screen.

Follow the same procedures to flip it back.

RESTRICTING OPERATION

The control can be restricted to prevent unwanted use or temperature adjustments.

From the main screen, activate temperature flashing. While temperature is flashing, press “Light” repeatedly until “LOCK” appears on the screen. Pressing the temperature up button allows you to toggle through “TEMP”, “OFF” and “ON”.

“TEMP” allows you to lock the temp./settings.

“ON” allows you to lock all settings/functions.

“OFF” does not lock the spa.

UNLOCKING

This Unlock sequence may be used from any screen that may be displayed on a restricted panel. While pressing and holding the Temperature Up button, slowly press the Light button twice. “UNLK” will display on the screen and after a few seconds, will revert to main screen.

ADJUSTING FILTRATION

Main Filtration

Filter cycles are set using a start time and a duration. Start time is indicated by an “A” or “P” in the bottom right corner of the display. Duration has no “A” or “P” indication. Each setting can be adjusted in 15-minute increments. The panel calculates the end time and displays

it automatically.

To enter filter cycles, activate temperature flashing and press the “Light” button repeatedly until the display reads “FLTR” (with a 1 in the bottom right corner). Pressing the Light button will bring you to the display “BEGN”.

The numbers flashing indicate numbers that can be changed. Scroll through with the up and down temperature buttons to choose what time your filter cycle will start and press the Light button to make your choice. “RUN” “HRS” will be on the display next. Again, scroll through the numbers to choose the duration of your filter cycle.

Filter Cycle 2 - Optional Filtration

Follow the same procedures under “FLTR” (with a 2 in the bottom right corner) to set up filter cycle 2.

It is possible to overlap Filter Cycle 1 and Filter Cycle 2, which will shorten overall filtration by the overlap amount.

Purge Cycles

In order to maintain sanitary conditions, secondary Pumps and/or a Blower will purge water from their respective plumbing by running briefly at the beginning of each filter cycle.

If Filter Cycle 1 is set for 24 hours, enabling Filter Cycle 2 will initiate a purge when Filter Cycle 2 is programmed to begin.

GFCI TEST FEATURE

A GFCI is an important safety device and is required equipment on hot tub installations in North America. Your spa may be equipped with a GFCI Protection feature. If so, a GFCI Trip Test must occur to allow proper spa function. Within 7 days after startup, the spa will trip the GFCI to test it. The GFCI must be reset once it has tripped. After passing the GFCI Trip Test, the spa will operate normally.

WIFI CONNECTIVITY

Some hot tubs can be equipped with optional WiFi connectivity to allow you to control the spa via a smart phone and an app.

For more information regarding WiFi, contact your local dealer or visit <https://www.balboawatergroup.com/ControlMySpa> for more info.



SPA SOAKING & EXERCISE GUIDELINES

1. Persons with heart disease, diabetes, blood pressure or circulatory abnormalities, a serious illness, or pregnant women should not enter a swim spa without prior consultation with their doctor.
2. People with skin, ear, genital, or other body infections, open sores or wound should not use the swim spa because of the possibility of spreading infection.
3. Before entering, look at the water in your swim spa. If there is cloudiness, foaming, or a strong chlorine smell is present, the water needs treatment. Properly maintained water will greatly reduce potential risk of skin rash (pseudomonas). Ask your Authorized Dealer for guidance.
4. Shower with soap and water before and after using the swim spa. Showering before use removes many common skin bacteria, perspiration, lotions, deodorants, creams, etc. that may reduce the effectiveness of the sanitizer and lessen the ability of the filter to work efficiently. Showering after use will help reduce skin irritation that may result from contact with sanitizing chemicals.
5. Before you begin training using your swim spa, please:
 - A. Ensure that the water is at a safe temperature for strenuous exercise
 - 83° - 86°F
 - 28.5° - 30°C
 - Any temperature higher or lower only under supervision of physician.
 - B. To maximize flow, turn off all non-swim jets by rotating their outer ring clockwise.
 - C. Set the Cascade (fountain) jets to their lowest level using the large diverter valve located at the end of the swim vessel.
 - D. Notify a responsible adult of your location and how long you intend to exercise.
6. Enter the swim spa slowly and cautiously. Be careful of your footing, and allow your body to gradually adjust to the water temperature. Exit slowly to accommodate relaxed leg muscles and possible light-headedness.
7. Soaking for too long may cause some users to feel nauseous, dizzy, or light-headed. If you wish to soak in high temperature water 104°F (40°C), leave the swim spa after 15 minutes, shower, cool down and then return for another brief stay. In lower temperatures (e.g. 98.6°F (37.5°C) - normal body temperature) most people can comfortably and safely soak for longer periods of sitting. If you have any questions about what is right for you, your family, or other guests, consult your doctor.

Never use the swim spa to swim, jog or exercise in hot water. Recommended water temperature for swimming and exercising is 83°F - 86°F (28.5°C - 30°C).

8. Never use the swim spa while under the influence of alcohol or drugs.
9. Consult your doctor about potential harmful effects of using drugs or medications while swimming, jogging, and exercising or hot water soaking in your swim spa.
10. **Never use the swim spa when you are alone. A responsible adult should check on you as you exercise.** The first rule of Aquatic Exercise is Safety. Always be sure that any swim spa user is under the supervision of a responsible adult who is capable of rescuing the swim spa user in case of an emergency.
11. Never allow children or elderly adults to use the swim spa unsupervised.
12. Never allow anyone to jump or dive into the swim spa. The water depth will not accommodate jumping or diving, and serious injury or possible death can result from these dangerous actions.
13. Consult your physician before beginning any new exercise regiment, including swimming, aqua-jogging, aquatic exercise and aquatic stretching.
14. When using the optional aquatic resistance exercise equipment, take care to always wear shatterproof goggles to protect your eyes in case you connect the attachment device incorrectly or should a band slip or break.
15. Never leave exercise equipment or other objects in swim spa when finished. They may create a trip or injury hazard if they are unseen below the surface of the water.
16. Closely monitor your physical condition when exercising in the swim spa. A general rule is that you should be able to talk normally while exercising. If you find it difficult to speak or think clearly during exercise, you should exit the swim spa until you are back to normal heart rate and can breathe freely.
17. Display all safety signs and rules located in the Owner Package for swim spa. Make sure that all users and guests understand the rules and know how to use the swim spa before allowing them to use it.
18. Swimming against the jets is similar to using a treadmill. You will want to pace your swim strokes and kicks to maintain your place in the water for an optimal workout. If you like to sprint during your workout, you can use the optional swim tether to give you maximum resistance when sprinting.
19. Always wear waterproof shoes when Aqua-Jogging for the best slip resistance and to protect your feet.
20. The bottom of the swim spa has contours built in for added structural integrity. Make yourself aware of those contours so that you know where they are as you exercise.
21. Always use swim-goggles when using your swim spa. Swim-goggles make it easier to see the bottom of the swim spa when swimming so that you can fix your position in the swim-lane. Swim-goggles also protect your eyes from continuous splashing during exercise. Whenever using resistance bands or swim tether, we recommend that you use shatter-proof swim-goggles.

22. Whenever using the optional resistance exercise bands, be sure that they are positively clipped into the attachment hardware on the swim spa. After attaching, give the cords a tug to ensure that they are latched. Always remove them from swim spa when you leave the swim spa. Keep resistance bands out of the reach of children.
23. Whenever using the optional swim-tether, be sure that it is positively seated in the pole retainer. If it is not properly installed, it can slip out of place and enter the swim spa causing possible injury.

24. Swim Spa Quick Training Guide:

1. To begin your workout, press each Jets button until you reach your desired swim velocity.
2. Warm up using the lower speeds
3. Raise the swim velocity with additional presses of the Jets buttons (Jets 1, Jets 2, Jets 3)
4. To lower the swim velocity, press the Jets buttons, turning them off until you reach the desired speed / jet pump combination
5. For your safety, the swim jets will automatically shut off after thirty minutes of operation. To swim longer, repeat steps 3 - 4 above as desired.
6. When finished swimming, be sure to turn the non-swim jets back on by rotating their outer ring counterclockwise. Leaving the non-swim jets closed prevents optimal heating and filtration.

- 25. Be safe, be healthy, have fun!**

EQUIPMENT SAFETY FEATURES

AUTOMATIC TIME OUTS

Your Spa is equipped with an automatic Time Out feature designed to protect both the equipment and the user. For your safety and to reduce unnecessary use of the pumps and lights, the Time Out feature turns selected accessories off automatically, as follows:

Accessory	Mode	Shuts off in...
Pump 1	Low	2 hours
Pump 1	High	30 minutes
Pump 2	High	30 minutes
Pump 3	High	30 minutes
Blower		30 minutes
Lights		1 hour

Common LCD Equipment Safety Messages

The following table describes the most common messages, possible causes, and corrective actions you may need to take:

If the LCD displays...	Indicates...	What happens...	Possible cause...	Corrective Action...
-OHH -HH -HTR T00 H0T -The heater is too hot	Overheat - one of the sensors has detected water temperature of 118°F+ (48°C+) inside the heater	Spa heater will automatically shut down until temperature falls below 108°F+ (42°C+)	- Low speed pump operating for an extended period of time - Programming error causing continuous filtering - Faulty Pump	- Make sure slice valves are open - Reprogram to ensure time cycles not overlapping - Contact dealer if problem persists
-OHS -DH -WATR T00 H0T -The water is too hot	Overheat - One sensor has detected temperature of spa water entering heater to be 110°F+ (43°C+)	Spa heater will automatically shut down until temperature falls below 108°F+ (42°C+)	- Low speed pump operating for an extended period of time - Programming error causing continuous filtering	- Open all jets - Make sure slice valves are open - Reprogram to ensure time cycles not overlapping - Contact dealer if problem persists
-HFL -HL -HTR FLOW LOSS -The water flow is low	Heater flow problem	Heater will shut down while spa continues to function normally	- Plugged filter - Low water	- Open all jets - Remove filter and clean - Add water - Contact dealer - Open all jets

If LCD displays...	Indicates...	What happens...	Possible cause...	Corrective Action...
- LF - LF - HTR FLOW FAIL - The water flow has failed	Water flow problem - Persistent flow problem	Heater will shut down while spa continues to function normally	- Plugged filter - Low water	- Remove filter and clean - Add water - Contact dealer - Open all jets
- drY - dy - HTR DRY - Heater is dry	Lack of water to the heater	Heater will shut down while spa continues to function normally	- Slice valve closed - Blocked suction return/filter/skimmer	- Add water - Contact dealer - Open all jets/valves - Remove blockage
- dr - dr - HTR MAY BE DRY - - WAIT - Heater may be dry	Lack of water to the heater	Heater will shut down while spa continues to function normally	- Slice valve closed - Blocked suction return/filter/skimmer	- Add Water - Open all jets/valves - Remove blockage
- SnT or SnH - SA or Sb - SNSR A - CALL FOR SRVC - - B - Sensor A fault, Sensor B fault	Heater sensor A or B not functioning	Spa automatically deactivated	- Non-functioning sensor	- Contact dealer for replacement sensor
- SnS - Sn - SNSR SYNC - - CALL FOR SRVC - - - Sensors are out of sync	Heater sensors are out of balance	Spa automatically deactivated	- Non-functioning sensor	- Contact dealer

COMMON LCD MESSAGES

The following table defines other messages you will frequently see on the LCD display:

Message...	What it is...	What it means...
Pr -OR- RUN/ PMPS/PURG/AIR/-- SLP	Priming mode	Spa is in normal Priming Mode operation
ECN	Sleep mode	Spa is in normal Sleep Mode operation
STD	Economy mode	Spa is in normal Economy Mode operation
ICE -OR- TOO COLD	Standard mode	Spa is in normal Standard Mode operation
- -	Freeze condition	Heater will come on to keep water above 45°F
WATR TOO HOT	Water temperature	Current water temperature not measured
	Water temperature	Spa water is too hot, functions disabled

MAINTENANCE

Cleaning and user maintenance shall not be made by children without supervision.

WATER CHEMISTRY

Water chemistry is critical in a spa system. Chemicals are used to sanitize the water and control the pH balance. The combination of high water temperature and small water volume means that the chemical balance must be watched carefully. It is recommended that you purchase a chemical start up kit, and the additional chemicals needed to maintain the proper/optimum chemical balance, from your dealer.

SANITIZING

Sanitizing the water destroys harmful organisms and keeps your spa healthy and safe. Three commonly used spa sanitizing or oxidizing agents are bromine, chlorine and ozone. Chlorine or bromine are chemicals that you add to the water. Ozone is a gas that is produced by an ozonator and injected into the water. It is important that a residual of sanitizer remain in your water. High water temperature, aeration and use will increase the need for sanitizer.

In addition to maintaining a residual, it is important to 'shock' your spa water periodically and after heavy use. This addition of substantial amounts of sanitizer super-chlorinates the water and oxidizes non-filterable organic residue. Allow the sanitizer level to drop back to the residual amount before using. Also use your Clean Up Cycle heavy use for additional filtration. Tests should be done daily with your test kit to keep a chlorine or bromine residual of 3.0 to 5.0 ppm.

PH LEVEL

pH is the balance of acidity and alkalinity in the water. Maintaining proper pH is important for the effectiveness of your sanitizer, for user comfort, and to prevent corrosion of the spa equipment.

Caution: Never mix two chemicals together.

Caution: Never store chemicals in the equipment compartment.

Caution: Do not use muriatic acid or Trichlor (pool chlorine) to balance pH as they will damage your spa surface and equipment.

Recommended Levels

pH:	7.2–7.6 (Ideal 7.4–7.6)
Sanitizer Residual:	3.5–5.0 ppm
Total Dissolved Solids:	100–200 ppm
Free Available Sanitizer:	3.0–5.0 ppm
Total Alkalinity:	80–100 ppm ideal for dichlor, trichlor, and bromine

NOTE: Make sure you use fresh test kit strips/chemicals. Test kits and test chemicals should be stored in a cool, dry location. Check the manufacturer's instructions to determine shelf life and expiration date.

WARNING - This appliance contains a UV emitter. Do not stare at the light source.

Water maintenance with the Ozone or UV Water Treatment System

Equipping your spa with an Ozone system that includes the Ozonator or UV Sanitizer is a smart decision. The use of ozone in

conjunction with spa sanitizing and water balancing chemicals helps to provide you with a cleaner, healthier spa, reduces chemical usage, and protects your skin from chemically induced irritation.

NOTE: The plastic material used in the UV Sanitizer is UV resistant.

SANITIZING WITH OZONE

Spas vary in size, and frequency and conditions of use. For this reason you will need to establish your sanitizing program based upon your own personal use. When using ozone, you should start by balancing your water chemistry as you normally would. A spa should run and be ozonated a minimum of four hours per day (minimum of six hours per day for a swim spa) during which time ozone will be mixed into the water. If your spa is heavily used, this run time should be increased. Your spa produces ozone during the filtration cycles. The amount of a residual sanitizer (chlorine or bromine) that you maintain in the water will also vary depending on use. It is recommended that you maintain a residual of 3.0-5.0 ppm. Periodically, and after periods of heavy use, it is necessary to 'shock' your spa with large amounts of sanitizer.

NOTE: Extra filtration can be provided by manually starting a clean-up cycle. Turn Pump 1 on low speed. The pump will operate for an extended period and then automatically turn off. The heater, ozone generator and UV system will also operate during this period if the controls are set in Standard or Ready mode.

SPECIALTY CHEMICALS

While ozone and UV may significantly reduce the usage of specialty chemicals (chlorine and

bromine), they are not a substitute for these chemicals. All chemicals should continue to be monitored, especially during periods of heavy usage and when changing or replenishing the spa water.

DRAINING YOUR SPA

NOTE: Always turn the circuit breaker off when you drain your spa. Do not turn the spa heater back on until you have full flow coming from the jets for several minutes. High concentrations of impurities caused by water evaporation, body oils, perfumes, and other contaminants may accumulate in the spa and cannot be filtered out.

NOTE: It is advisable to drain your spa and refill it with fresh water every six to eight weeks or more often, depending on the amount of use.

All spas are equipped with external drains. The external drain is used for draining the spa.

NOTE: The drain on the 982 is located inside the cabinet of the spa.

NOTE: Use a standard garden hose to direct the water to an appropriate disposal area.

The external drain valve is located at the base of the spa below the side panel, usually on the front left corner of the spa. Remove the outer black cap and connect a garden hose to the fitting. Turn the ring on the back of the valve counter-clockwise until it stops, then pull out to open the valve. Water will begin to flow. When flow stops, push in the valve, turn ring clockwise until it stops, remove hose and replace the cap.

NOTE: Do NOT attempt to use the pump to drain the spa.

NOTE: Close and replace caps on all drains prior to refilling the spa.

NOTE: When refilling the spa, you may need to bleed air from the system. Refer to Priming Your Spa for instructions.

FILTER MAINTENANCE

NOTE: It is not necessary to drain the spa in order to clean the filter.

The removable filter cartridge is located in the filter canister behind the skimmer.

The filter should be inspected/cleaned monthly during normal use, and more often when spa use is heavy.

Your filtration system may also include a First Filter, an additional filter that is placed on top of the skimmer basket and pressed into place. This filter aids the collection of microscopic organic matter, debris, hair, soap residue and body oils. To clean this filter, remove, rinse or soak in cartridge cleaner as directed, and reinstall. When First Filter is no longer white after cleaning, replace with a new filter. These can be purchased from your dealer.

Keep the filter cartridge clean! Clean the filter cartridge at least once every 90 days. A clogged filter decreases performance and degrades water quality.

To clean the filter cartridge:

1. Turn the pump off.
2. Remove skimmer lid on top of spa filter area.
3. Remove strainer basket
4. Remove filter cartridge from the filter canister

by grasping the top and lifting upwards. Some filters are threaded on.

5. Soak filter in a commercial filter cleaner/degreaser, available from your local dealer, per manufacturer's instructions. Hose out filter cartridge or replace with new cartridge, if needed.
6. Place filter cartridge back into filter canister. When the spa is empty, the weir door may block the filter canister. You must hold it out of the way when reinstalling the cartridge. When the spa is full, the door will float so you will have easy access for installing the filter cartridge
7. Replace strainer basket and skimmer lid.
8. Turn the pump ON.

Replacing the filter cartridge annually is recommended (semi-annually for swim spas) to maintain optimum performance. Filter maintenance depends on usage.

WINTERIZING

In cold climates where freezing temperatures occur, special care is required to prevent the possibility of damage to the spa and equipment due to freezing. If you plan on using your spa during cold months, be sure your pump and heater are in good working order. The spa shell has been insulated to provide efficient operation in cold weather areas.

NOTE: If you elect not to drain your spa and the temperature is going to be below freezing for extended periods of time, it is best to operate the spa heater at the maximum high temperature, 104°F (40°C), especially if there is a power outage threat. This will help keep the spa water from freezing if you have a power failure.

If you do not intend to use your spa during the winter months and there is danger of freezing, use the following steps to winterize your spa:

1. Turn off all electrical power to the spa.
2. Drain spa and hoses of all water using the directions for Draining Your Spa.
Open all unions, and remove drain plugs from bottom of pumps. If you cannot draw off all of the water (especially from hoses), add Recreational Vehicle antifreeze to the remaining water through the bottom of the skimmer and jets. If antifreeze is used, contact your dealer for advice.

NOTE: Prior to refilling the spa, drain all antifreeze from spa and hoses using the instructions for Draining Your Spa. Carefully monitor chemicals until all antifreeze residue has dissipated.

3. The filter should be drained, and the cartridge removed and cleaned.
4. Check to see that there is no water in the heater element chamber.
5. Clean your spa as directed in the following two sections on this page.
6. Cover your spa with a water-shedding, impenetrable cover.
7. For further information on blowing out the plumbing lines and winterizing procedures, contact your local dealer.

SPA CABINET CARE

The cabinets are made of a high quality alternative to wood that is virtually maintenance free, requiring no staining, sealing, or waxing. To clean the spa cabinet,

rinse dirt and dust regularly with clear water. To remove stubborn dirt, grime, and mild discoloration, wash with a mild detergent and warm water.

Never use abrasive cleaners.

SPA SURFACE CARE AND CLEANING

Your spa shell surface is made of acrylic. A minimum amount of care and cleaning will keep your spa looking new for years. Use a spa cleaner for residue and lime build-up at the water level of the spa surface. It may be necessary to lower the water level 5-7 cm (2-3") before cleaning to avoid polluting the spa. Cleaner can be applied to the acrylic surface with a soft cloth and wiped clean. Use a non-abrasive household cleaner to clean your spa shell or use a mild dishwashing detergent, such as Ivory®Liquid. Rinse well and dry with a clean cloth.

NOTE: Do not allow the acrylic surface to come in to contact with products such as acetone (nail polish remover), nail polish, dry cleaning solution, lacquer thinners, gasoline, pine oil, etc.

Remove dust and dry dirt with a soft, damp cloth. Clean grease, oil, paint and ink stains with isopropyl (rubbing) alcohol. Avoid using razor blades or other sharp instruments that might scratch the surface.

Protect Spa Finish - always keep cover on the spa when not in use.

COMMON WATER PROBLEMS

Problem	Usual Cause	Solution
Cloudy Water	<ul style="list-style-type: none"> - Inadequate filtration/ dirty filter - Excessive oils/organic matter - Improper sanitation/ bacteria - High pH and/or high alkalinity 	<ul style="list-style-type: none"> - Check to make sure the filter is running properly; clean filter with a filter cleaner or degreaser - Shock the spa with a chlorine or bromine sanitizer, or other shock treatment product - Increase sanitizer level to balance water and shock if needed - Adjust pH; add appropriate sodium bisulfate product - Use clarifier <p>NOTE: If using an ozone generator, consult with your dealer before using polymer based clarifiers</p> <ul style="list-style-type: none"> - Depending on the severity, drain the spa completely, clean and refill
Water Odor	<ul style="list-style-type: none"> - Excessive organics or chloramines; insufficient free available sanitizer - Improper sanitation - Inadequate filtration - Low pH 	<ul style="list-style-type: none"> - Shock the spa with a chlorine or bromine sanitizer/shock, or other shock treatment product - Increase sanitizer level to balance water; shock if needed - Check to make sure the filter is running properly; clean filter with a filter cleaner or degreaser - Raise pH with sodium bicarbonate product. - If metals are present, add chelating agent.
Chlorine Odor	<ul style="list-style-type: none"> - Too many chloramines/ insufficient free available chlorine - Low pH 	<ul style="list-style-type: none"> - Shock the spa with a chlorine available chlorine sanitizer/shock, or non-chlorine shock treatment - Adjust pH; raise pH with sodium bicarbonate product
Bromine Odor/ Yellow Water	<ul style="list-style-type: none"> - Low pH 	<ul style="list-style-type: none"> - Adjust pH; raise pH with sodium bicarbonate product

Problem	Usual Cause	Solution
Musty Odor	<ul style="list-style-type: none"> - Bacterial or algae growth 	<ul style="list-style-type: none"> - Shock spa with a chlorine or bromine sanitizer/shock, of equivalent shock treatment product. If problem is visible, drain, clean, refill and balance spa
Foaming/ Scum Ring Around the tub	<ul style="list-style-type: none"> - Build up of body oils, lotion and chemicals resulting from soap or detergent 	<ul style="list-style-type: none"> - Skim foam off using your leaf net or drain and refill
Algae	<ul style="list-style-type: none"> - pH Imbalance - Low free chlorine or bromine 	<ul style="list-style-type: none"> - Adjust pH - Shock with a chlorine or bromine
Eye Irritation	<ul style="list-style-type: none"> - Low pH - Insufficient free available chlorine 	<ul style="list-style-type: none"> - Raise pH with sodium bicarbonate product - Shock with a chlorine sanitizer/shock or other shock treatment product
Skin Irritation/ Rash	<ul style="list-style-type: none"> - Unsanitary/polluted water - Soaking too long - Chemicals not balanced, excessive ozone 	<ul style="list-style-type: none"> - Keep recommended sanitizer residual at all times; superchlorinate or use a non-chlorine shock treatment - Soak for smaller intervals, such as 15 minutes - Correct chemical imbalance
Scale	<ul style="list-style-type: none"> - Too much calcium dissolved in water - pH and total alkalinity too high 	<ul style="list-style-type: none"> - Add a scale control product. Adjust total alkalinity and pH levels by adding the appropriate sodium bisulfate product; for concentrated scale deposits - Drain spa, scrub the scale off, refill the spa and balance the water
Erratic pH Test Results/Unusual pH Test Color	<ul style="list-style-type: none"> - Sanitizer level too high - Old pH indicator dye 	<ul style="list-style-type: none"> - Test the pH, when the sanitizer level is below 5 ppm - Replace the pH indicator dye

Problem	Usual Cause	Solution
Sanitizer Dissipating Too Rapidly	<ul style="list-style-type: none"> - Excessive organics in water - Temperature too high - Low pH - Low pH corrosion of metal fixtures - Low calcium hardness - Low total alkalinity 	<ul style="list-style-type: none"> - Increase shock dosage; add sanitizer; shower before entering spa - Reduce temperature - Raise pH with sodium bicarbonate product - Use chelating agent if metals are present. Keep proper pH level (7.2 to 7.6). - Use chelating agent if metals are present. Maintain minimum 150-200 ppm calcium hardness - Use chelating agent if metals are present. Maintain proper alkalinity for type of sanitizer used.

NOTE: If your source water has a high metal or mineral content, a specialty chemical should be used to avoid staining or accumulation of deposits. These guidelines cover the most common water problems when operating a spa with ozone. Contact your dealer for further information regarding chemical control issues.

COMMON HARDWARE PROBLEMS

Problem	Usual Cause	Solution
System not operating	<ul style="list-style-type: none"> - House circuit breaker tripped or in OFF position 	<ul style="list-style-type: none"> - Reset circuit breaker on house breaker panel
Heater not operating	<ul style="list-style-type: none"> - Water level too low - Heater mode not selected - No power to heater - Heater not operating - Jets are closed 	<ul style="list-style-type: none"> - Add water to reach 6" (15.5cm) below top lip of spa - Open all jets - Refer to temperature/heater functioning. - Check house circuit breaker - Contact dealer
Water not clean	<ul style="list-style-type: none"> - Clogged or blocked floor suction or skimmer - Filter clogged (dirty) - Poor water chemistry - Insufficient filtering time - Improper maintenance - High content of solids in water 	<ul style="list-style-type: none"> - Clean floor suction/skimmer. - Remove blockage - Clean or replace - See Maintenance section - Run filtration mode longer - Contact dealer - Use clarifier or drain and refill spa
Abnormal water usage	<ul style="list-style-type: none"> - Excessive evaporation and/or splashing 	<ul style="list-style-type: none"> - Use spa cover and refill as necessary
Overheating	<ul style="list-style-type: none"> - High ambient temperature 	<ul style="list-style-type: none"> - Contact dealer
Low water flow from jets	<ul style="list-style-type: none"> - Operating in FILTER mode-low speed - Clogged or blocked suction or skimmer - Dirty filter - Jets in OFF position - Slice valves closed 	<ul style="list-style-type: none"> - Select hi-speed jets - Clean floor suction/skimmer. - Remove blockage - Clean or replace - Open jets - Contact dealer
Noisy pump and motor	<ul style="list-style-type: none"> - Clogged floor suction or skimmer - Low water level - Damaged or worn motor bearings 	<ul style="list-style-type: none"> - Clean floor suction/skimmer - Add water to normal water level (6" or 15.5 cm below lip) - Contact dealer

Problem	Usual Cause	Solution
No water flow from jets	<ul style="list-style-type: none"> - Pump not primed - Adjustable jets turned off - House circuit breaker tripped, no power to system - Faulty pump or motor - Pump surges - Slice valves closed 	<ul style="list-style-type: none"> - See Priming section - Turn on jets - Reset circuit breaker at house panel - Low water. Check level on Weir door - Contact dealer
Water leakage from under spa	<ul style="list-style-type: none"> - Check unions & drain hoses 	<ul style="list-style-type: none"> - Close or tighten as necessary
No air flow from jets	<ul style="list-style-type: none"> - Air control not open - Jet nozzle not seated properly - Jet nozzle missing 	<ul style="list-style-type: none"> - Open control - Check jet nozzles - Inspect jets and replace as needed
Motor will not operate	<ul style="list-style-type: none"> - House circuit breaker tripped or in OFF position - Improper or defective wiring or electrical supply - Thermal Overload Protection switch tripped 	<ul style="list-style-type: none"> - Reset circuit breaker - Contact dealer - Auto reset after motor has cooled. Contact dealer if motor continues to cycle
Black powder film around water line	<ul style="list-style-type: none"> - Wearing in of turbo/blower brushes 	<ul style="list-style-type: none"> - Will disappear after use
The spa will not shut off	<ul style="list-style-type: none"> - Spa trying to heat - Spa is in filter cycle - Spa is in Standard or Ready Mode 	<ul style="list-style-type: none"> - Check 'Set Temperature' in Standard Mode - Normal. No need to change - Check mode setting

SAFETY SIGN

The safety sign enclosed with your Owner's Manual should be permanently installed where visible to all users of the spa. This sign is adhesive backed and includes four screws for mounting the sign on rough surfaces. It is very important that you, as a spa owner, review the important safety instructions and warnings before you operate your spa. It is equally important that you instruct all users, even occasional ones, as to the warnings associated with spa use.

You may obtain additional signs by contacting :

USA: MAAX Spas Industries Corp..
Customer Service
25605 South Arizona Avenue
Chandler, Arizona 85248
www.maaxspas.com

LIMITED WARRANTY SUMMARY

Please refer to the Warranty Card included with your product for complete warranty information. In order to receive prompt warranty service, you must return your warranty card, completed with model and serial number, to your dealer immediately upon completion of the spa installation. MAAX Spas Industries Corp. provides a limited warranty to our customers. It applies to the spa structure, surface, plumbing, pumps, heater, blower, and controls. The limited warranty does not cover damage resulting from improper maintenance, improper installation, misuse, abuse, accident, fire, normal wear and tear, or improper water maintenance. Unauthorized modifications of the spa may void the warranty. Replacement cost associated with transportation, removal and reinstallation are the sole responsibility of the spa owner. MAAX Spas Industries Corp., reserves the right to make changes in design or material of its products at any time without incurring liability. This limited warranty applies to the first retail purchaser and terminates upon any transfer of ownership.

COPYRIGHTS AND TRADEMARKS

©Copyright 2022 MAAX Spas Industries Corp.. All rights reserved. No parts of this publication may be reproduced, stored in a retrieval system, or transmitted, in any form or by any means (electronic, mechanical, photocopying, recording or otherwise), without prior written permission.

Disclaimer:

The information in this manual is accurate to the best of MAAX Spas Industries Corp.'s knowledge. However, MAAX Spas Industries Corp. assumes no responsibility for errors or omissions. Nor is any liability assumed for damages resulting from use of the information contained herein. Specifications subject to change without notice. Spas shown at variable percentage of actual size.

Congratulations on your purchase of a MAAX® Spas product. Your Owner's Manual provides installation, operation and maintenance instructions.

Please review it and keep it for future references.

**Save These Instructions
Owner's Record Information**

Date Purchases : _____

Purchased From : _____

Phone Number : _____

Installed By : _____

Serial Number : _____ Model : _____

NOTES
